

型号Typ	200	225	250	280	315	355	400	450	500	560	630	710	800	900	1000	
A	256	288	322	361	404	453	507	569	638	715	801	898	1007	1130	1267	
B	296	328	362	417	460	509	563	625	694	771	857	954	1063	1186	1323	
C	138	154	171	195.5	217	241.5	-	-	-	-	-	-	-	-	-	
D													200	250	300	350
E							200	200	250	250	300	400	500	600	700	
F							168.5	199.5	209	247.5	265.5	264	268.5	280	298.5	

图2 (Fig 2)

风机性能

Performance of Ventilator

1. 该样本中风机性能均指在标准状态下的性能, 即风机进气状态为:

进气压力 $P_a = 101.325\text{KPa}$
 进气温度 $t = 20\text{ }^\circ\text{C}$
 进气气体密度 $\rho = 1.2\text{Kg/m}^3$

若用户实际使用的气体进气状态或使用的风机转速改变时则可按下列关系式换算:

$$\frac{Q_0'}{Q_0} = \frac{n'}{n}$$

$$\frac{P_0'}{P_0} = \frac{n'^2}{n^2} \cdot \frac{\rho'}{\rho} \quad \frac{P_0'}{P_0} = \frac{n'^2}{n^2} \cdot \frac{P_a'}{P_a} \cdot \frac{273+t}{273+t'}$$

$$\frac{Nin_0'}{Nin_0} = \frac{n'^3}{n^3} \cdot \frac{\rho'}{\rho} \quad \frac{Nin_0'}{Nin_0} = \frac{n'^3}{n^3} \cdot \frac{P_a'}{P_a} \cdot \frac{273+t}{273+t'}$$

上述式中

- 流量 Q_0 (m^3/h)、全压 P_0 (Pa)、转速 n (r/min)、内功率 Nin_0 (Kw)由性能曲线图上查得。
- 右上角加符号“x”的则为用户实际使用气体进气状态下所需的性能参数。
- 上式中略去了相对湿度的差别。

1. The ventilator performance in this catalogue denotes the performance in standard conditions. It denotes air inlet conditions of ventilator as follows:

Air inlet pressure $P_a = 101.325\text{KPa}$
 Air temperature $t = 20\text{ }^\circ\text{C}$
 Inlet gas density $\rho = 1.2\text{Kg/m}^3$

If the practical air inlet conditions of customer or the speed of the operating ventilator changes, the conversion can be carried out according to the following expression:

$$\frac{Q_0'}{Q_0} = \frac{n'}{n}$$

$$\frac{P_0'}{P_0} = \frac{n'^2}{n^2} \cdot \frac{\rho'}{\rho} \quad \frac{P_0'}{P_0} = \frac{n'^2}{n^2} \cdot \frac{P_a'}{P_a} \cdot \frac{273+t}{273+t'}$$

$$\frac{Nin_0'}{Nin_0} = \frac{n'^3}{n^3} \cdot \frac{\rho'}{\rho} \quad \frac{Nin_0'}{Nin_0} = \frac{n'^3}{n^3} \cdot \frac{P_a'}{P_a} \cdot \frac{273+t}{273+t'}$$

where:

- Volume Q_0 (m^3/h), total pressure P_0 (Pa), speed n (r/min) can be obtained from Performance chart.
- Asterisk (*) on the upper right corner denotes the performance parameter needed by the customers in practical gas inlet conditions.
- The difference in relative humidity is omitted from the above-mentioned formulas.



2. 性能曲线图上的功率 Nin_0 是指风机的内功率。

- 风机轴功率: $N_s = Nin_0 / \eta_m$
 式中: N_s - 风机轴功率
 η_m - 风机机械效率
 风机机械效率的取值方法可参照表1。

2. The power (Nin_0) on the performance chart the internal power of the ventilator.

- Shaft power of ventilator: $N_s = Nin_0 / \eta_m$
 where: N_s - Shaft power of ventilator
 η_m - Mechanical efficiency of ventilator
 The value of mechanical efficiency of ventilator can be obtained from Table 1.

风机传动方式Way of ventilator driving	η_m
电机直联传动electric motor directly driven	1
联轴器直联传动Coupling directly driven	0.98
三角皮带传动V-belt driven	0.95

表1 (Table1)

(2) 配套电机的功率: $N = N_s \cdot K$
 式中: N - 配套电机的功率
 K - 电机容量安全系数

电机容量安全系数的取值方法可参照表2。

(2) The rated power of the drive motor equals the total required shaft input power multiplied by the safety factor:

$N = N_s \cdot K$
 where: N = rated power of drive motor
 K = required safety factor

The required safety factor is provided in Table 2.

电机功率Power of electric motor(Kw)	K值Value k
$\leq 2.2\text{Kw}$	1.2
$\leq 7.5\text{Kw}$	1.15
$\geq 11\text{Kw}$	1.1

表2 (Table2)

3. 噪声: 噪声等级显示在每个性能表上。
 Lw_iA 为总声功率级的A计权声级。计算所得的总声功率级用表3中倍频谱的A计权衰减值换算至A声功率级。

3. Noise: The noise levels shown on each performance chart. Lw_iA refer to the overall sound power "A-Weighted" levels. The computed sound power levels were converted into A-Weighted levels using adjustments to the octave band spectrum as follows:

中心频率 Center Frequency Hz	63	125	250	500	1000	2000	4000	8000
调整为A-Weighted Adjustment dB(A)	-25.5	-12.5	-8.5	-3	0	+1	+1	-1

表3 (Table3)

总声压级 Lp_iA 能利用总声能等级按如下公式计算:
 无边界状态: $Lp_iA = Lw_{ia} - (20 \log_{10} d) - 11$
 室内状态: $Lp_iA = Lw_{ia} - (20 \log_{10} d) - 7$
 式中: d = 离风机距离(m)

The overall sound pressure levels, Lp_iA , can be computed from the overall sound power levels as follows:
 Free Field Conditions: $Lp_iA = Lw_{ia} - (20 \log_{10} d) - 11$
 Room Conditions: $Lp_iA = Lw_{ia} - (20 \log_{10} d) - 7$
 Where: d = distance from fan in meters.

4. L2 型、R2型、K2型双联风机性能与 L 型、R 型、K型风机曲线所示性能比较, 在压力相同情况下, 双联风机性能如下:

风量 x 2
 转速 x 1.05
 内功率 x 2.15
 噪声 +3

Volume x 2
 Speed x 1.05
 Inner Power x 2.15
 Noise +3

双联风机的性能未获 AMCA International 授权。

Performance of twin ventilators are not licensed by AMCA International.

皮带传动安装

V-BELT DRIVE INSTALLATION

1. 拆除风机轴端的保护并检查有无缺口和毛刺;
2. 检查风机和电机轴之间的平行度;
3. 中心距控制在 $0.7(d1+d2) < a < 2(d1+d2)$, 前向风机皮带速度应控制在10~15m/s; 后向风机皮带速度应控制在25~35m/s;
4. 将皮带轮套在轴上滑进去, 不要敲击, 以免损伤轴承;
5. 用一根直尺把风机和电机上的带轮对齐并紧固;
6. 把皮带套进皮带轮, 不要撬、挤压, 以免损伤皮带;
7. 调整张紧度直至皮带看起来松紧适度, 风机运行几分钟后, 再调整皮带至合适的张紧度;
8. 关掉风机, 移动电机座以调整张紧度, 当风机工作时, 皮带紧的一边应是两个皮带轮连成的一直线, 松的一边有轻微弧形。

1. Remove the protective coating from the ends of the fan shaft and assure that the shaft ends are free of nicks and burrs.
2. Check fan and motor shafts for parallel and angular alignment.
3. The center distance must be controlled as $0.7(d1+d2) < 2(d1+d2)$; the belt speed of forward fan should be more than 10m/s, but less than 15m/s, (10<v<15m/s); the belt speed of backward fan should be more than 25m/s, but less than 35m/s, (25<v<35m/s);
4. Slide sheaves on to the shafts—do not drive the sheaves on to the shafts as this may result in bearing damage.
5. Align fan and motor sheaves with a straight-edge or string, and tighten.
6. Place belts over the sheaves with carefull, otherwise the belts will be damaged.
7. Adjust the belt tension until the belts appear snug. Run the unit for a few minutes and allow the belts to set properly.
8. Switch off the fan, adjust the belt tension by moving the motor base. When in operation, the tight side of the belts should be in a straight line from sheave to sheave and there should be a slight bow on the slack side.

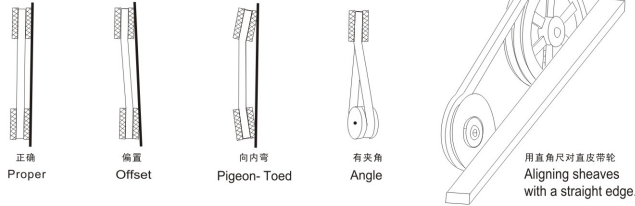

皮带松紧度

Belt tension

合适的皮带松紧度对使用寿命来说很重要太紧会给皮带和轴承带来额外的负载, 降低它们的使用寿命, 太松会出现皮带打滑现象而产生热能并降低使用寿命。
皮带松紧度量具用来判断皮带是否松紧合适。量具本身带有一个尺表, 根据皮带轮中心距和皮带横截面确定皮带张紧力的大小, 如图4和表3。

A proper level of belt tension is required in order to obtain a satisfactory belt life. If the belt tension level is too high, then excessive loads will be imposed on the belts and the bearings, and this will reduce the lives of both of these components. If the belt tension level is too low, then the belt will slip. Belt slippage generates a large amount of heat, and this heat will drastically reduce the life of a belt.
Belt-tensioning gauges can be used to determine whether the belts are tensioned properly. A chart is normally supplied with the gauge which indicates the ranges of forces required to deflect the belts by a given amount to obtain the proper belt tension level. The required forces are based upon the center distance of the sheaves and the belt cross-section. The belts are properly tensioned when the forces required to deflect the belt are within the specified range, see Fig 4 and Table 3.

如果没有皮带张紧度量具, 应调节皮带松紧至风机启动时皮带不发出尖叫声为止, 如发出短促的叫声是允许的。
拉紧皮带后、开动风机之前, 重新检查皮带轮的对齐情况, 如有必要则重新调整对齐。新皮带在开始使用时可能有点拉伸, 则应在运行几天后重新检查皮带张紧度。

与中心距有关的皮带张紧度指示
Belt tension indicator applied to mid centre distance.



图4 (Fig4)

If a belt-tensioning gauge is not available, then the belt should be tightened just enough so that the belt does not squeal when the ventilator is started. A very short period of noise during the starting of a ventilator is allowable, but a squeal lasting several seconds or longer is not acceptable. After tensioning the belts and before starting the ventilator, check to make sure that the sheaves are properly aligned.
Realign the sheaves if necessary. Note that new belts may stretch a little during initial use, so the belt tension level should be checked after a few day of operation.

皮带截面 Belt Section	使皮带向下移动16mm径向距离1米所需的力 Force required to deflect belt 16mm per metre of span		
	张紧力 (小皮带轮直径) Small Pulley Diameter (mm)	牛顿	千克力 Kilogram force (Kgf)
SPZ	56-95	13-20	1.3-2.0
	100-140	20-25	2.0-2.5
SPA	80-132	25-35	2.5-3.6
	140-200	35-45	3.6-4.6
SPB	112-224	45-65	4.6-6.6
	236-315	65-85	6.6-8.7
SPC	224-335	85-115	8.7-11.7
	375-560	115-150	11.7-15.3
A	80-140	10-15	1.1-1.5
B	125-200	20-30	2.0-3.1

表3 (Table3)

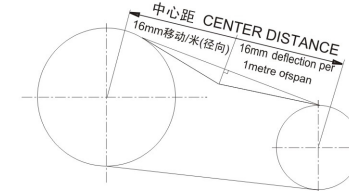
轴承润滑

Bearing Lubrication

风机使用带座轴承, 可通过加油嘴注入润滑油。润滑油有效期取决于油脂类型、轴承的转速和工作温度。判断是否加油的最好办法是当加新油时观察清除下来的旧油脂, 如果清除下来的油脂看起来还是新的, 可延长换油脂的间隔, 如果清除下来的油脂比新的黑得多表明油脂已氧化, 应缩短换油脂的间隔。

The ventilator bearings are filled with lubricant when they come from the factory, so the bearings do not require any additional grease to be supplied before starting the ventilator.
The ventilator that are equipped with pillow block bearings are provided with lubrication fittings, and these fittings allow for additional lubrication to be supplied to the bearings at regular intervals. The allowable period of time between lubrication of these bearings depends upon the operating speeds and temperatures of the bearing as well as on the type of grease used. The best way to determine the required frequency of lubrication is to inspect the condition of the grease that is discharged from the seals when new grease is added. If the discharged grease looks similar to the new grease, then a longer period of time between lubrications is possible. If the discharged grease is much darker than the new grease, then this indicates that the grease is being oxidized and more frequent lubrications of the bearings are required.

说明

Instructions

1) . 订货时须注明风机型号、转速、风量、风压、出风口方向和旋转方向。若需配套皮带、皮带轮、电机、安装底座等配件及其它特殊要求可在订货时提出。

1) . During ordering it is necessary to state the type of ventilator, speed, air volume, air pressure, direction of air outlet, rotating direction, type of electric motor and its specifications.



- 在安装前应对风机各部件进行检查，对叶轮、主轴和轴承等主要机件应重点细致检查，若有损伤应修复后再安装使用。
- 检查机壳和其它壳体内部，不应有掉入、遗留的工具和杂物。
- 风机正式运转前，需检查电机的转向是否符合风机转向的要求。
- 风管与出风口之间应采用软连接，接头不得拉紧。
- 风机安装后用手或杠杆拨动叶轮，检查是否过紧或碰撞现象，确认无这些现象后方可进行试转。
- 风机配用电机功率是指在特定工况下，风机内功率加上机械损失与电机容量安全系数而言，并非出风口全敞开时所需的功率，为防止电机超功率运转而烧毁，严禁风机出风口或进风口不接管路或未加外界任何阻力进行空运转。
- 风机在无较大腐蚀性气体、不含酸（碱）性和尘颗粒物小于150mg/m³的气体、温度小于85℃大于-20℃的气体环境下使用，风机在运输装卸过程中应小心轻放，防止碰撞挤压。

- Prior to installation, the ventilator should be carefully inspected. Special care should be taken in checking the shaft, impeller and bearings. If there is an indication of any damage, then the damaged parts should be repaired or replaced before the ventilator is installed or operated.
- The inside of the scroll and casing need to be checked to make sure that there are no foreign objects contained therein, such as tools or loose parts.
- The rotational directions of the motor and impeller should be checked to assure that they are consistent with each other.
- A flexible connector should be used between the ventilator outlet flange and its mating pipe. The bolts used to fasten the outlet flange to the pipe should not be over-tightened.
- Following the installation, the impeller should be turned by hand or with the use of a wrench to make sure that it turns freely. Once this is verified, the ventilator can be operated normally.
- The rated motor power as calculated herein is not sufficient to drive the ventilator with an unrestricted discharge flow path. Operating the ventilator with an unrestricted discharge flow path will result in flow rates that exceed the ventilator flow rate capabilities, and such operation will quickly burn out the motor. So care must be taken in operating the ventilators to make sure that the maximum rated flows, as provided on the performance charts in this brochure, are not exceeded.
- This fan is restricted for use in areas where air substances are non-corrosive and non-toxic non-alkaline or where dust particles < 150mg/m³, -20℃ < temperature < 85℃. If special conditions during transportation, load and unload, it is strictly prohibited to shock the ventilators.

示例图例

Example Of Curve Reading

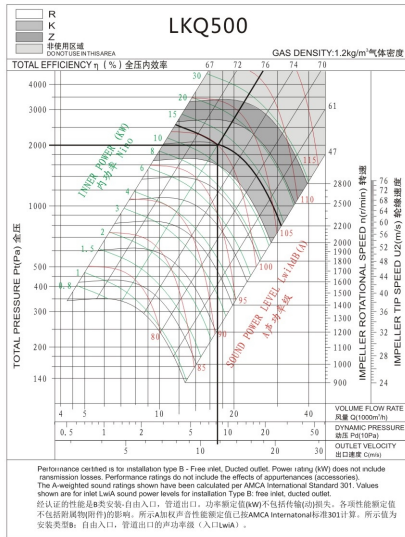

风量
Volume V=17600 m³/h

全压
Total Pressure Pt=2000 Pa

动压
Dynamic Pressure Pd=82Pa

出口速度
Outlet Velocity C=11.7 m/s

转速
Speed n=2200 r/min

轮缘速度
Impeller Tip Speed U_e=59 m/s

内功率
Inner Power N_{ino}=12.8 kW

声功率级
Sound Power Level L_{wi} A=100dB(A)

全压内效率
Total Pressure Efficiency η=76%

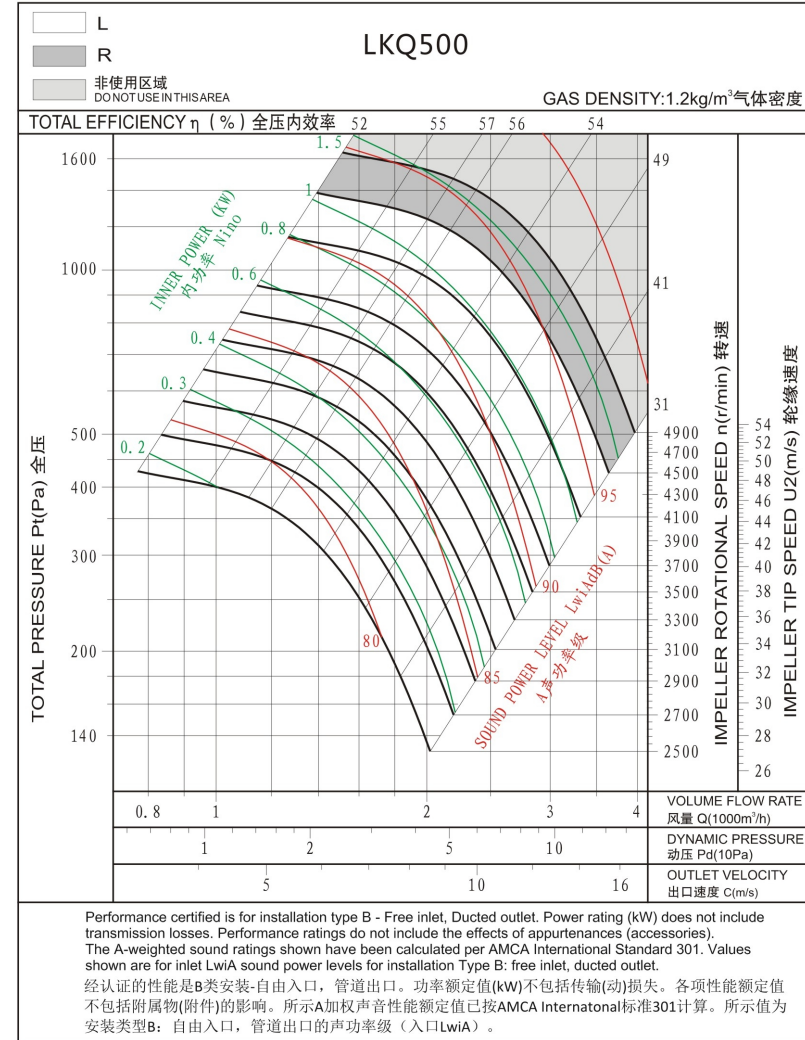

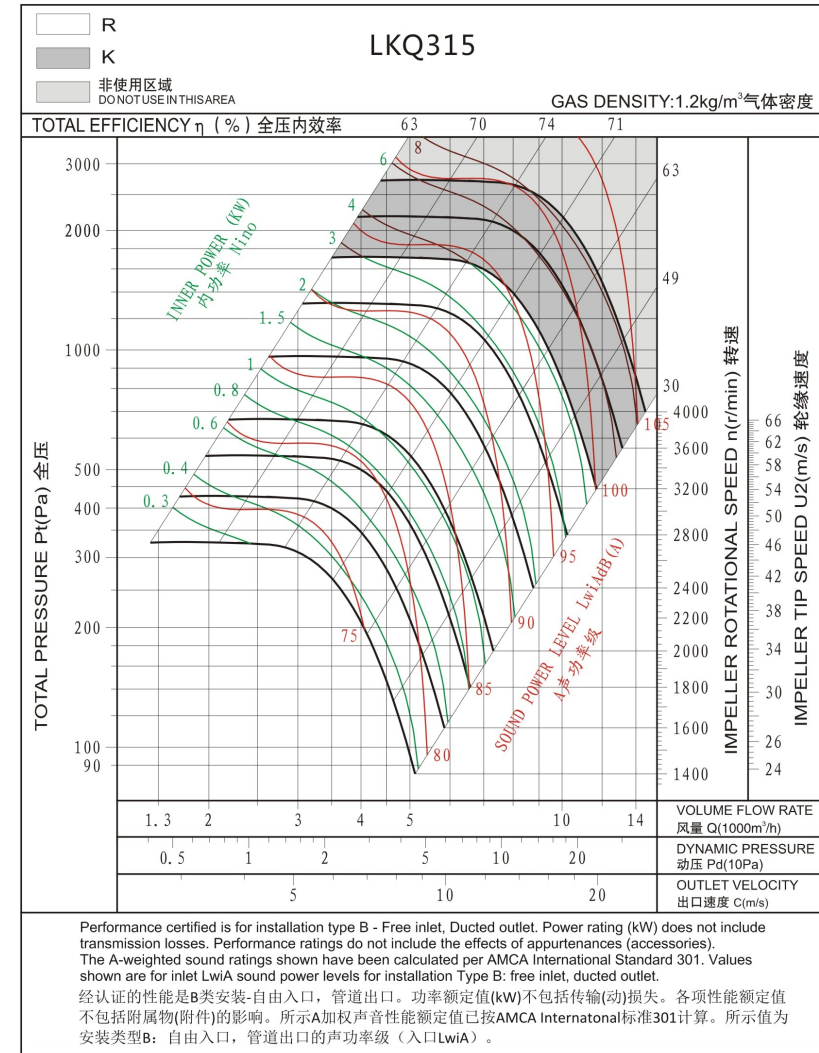
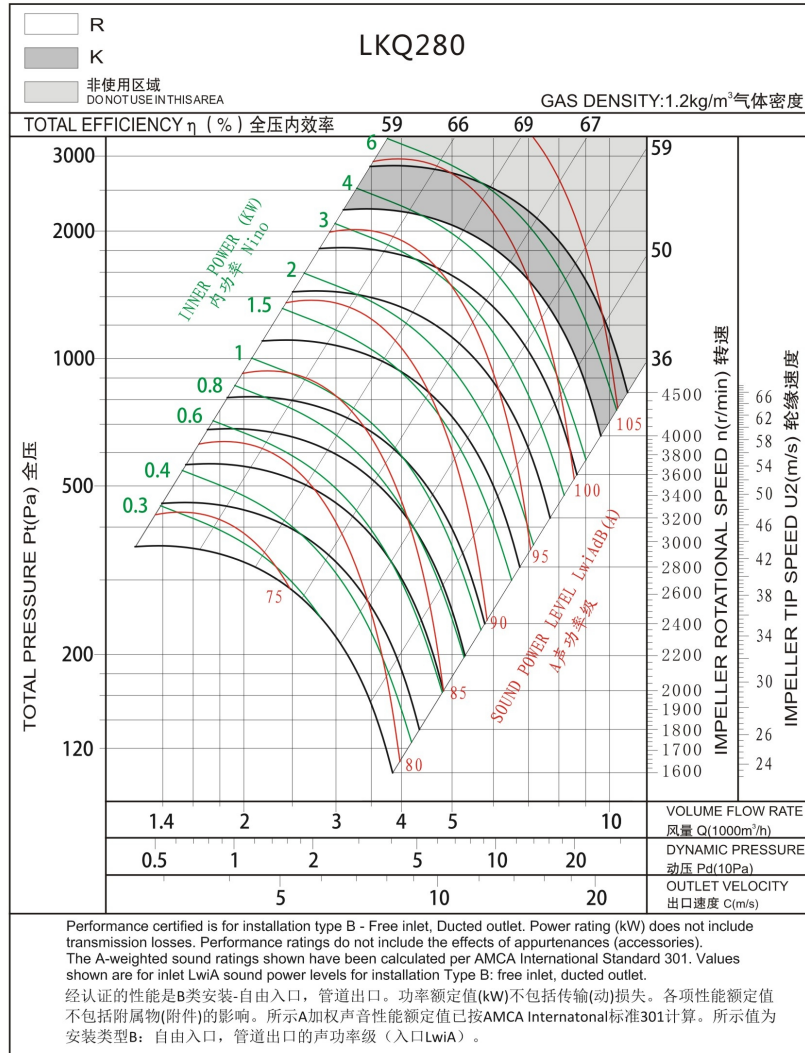

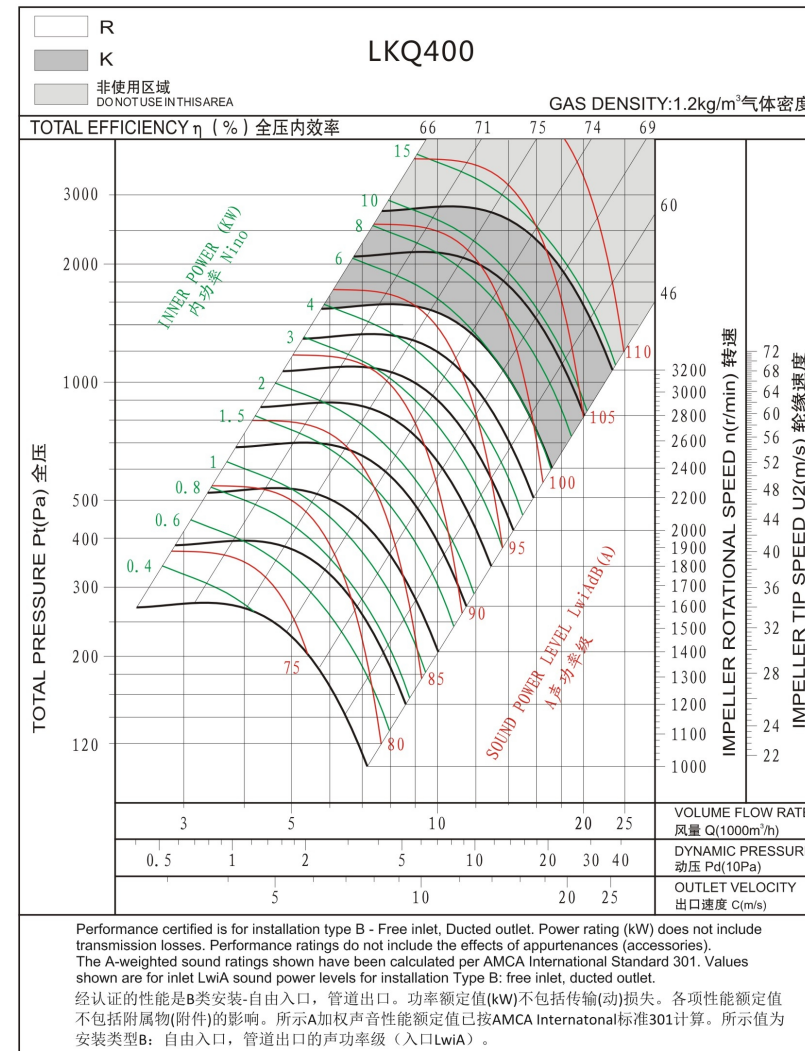
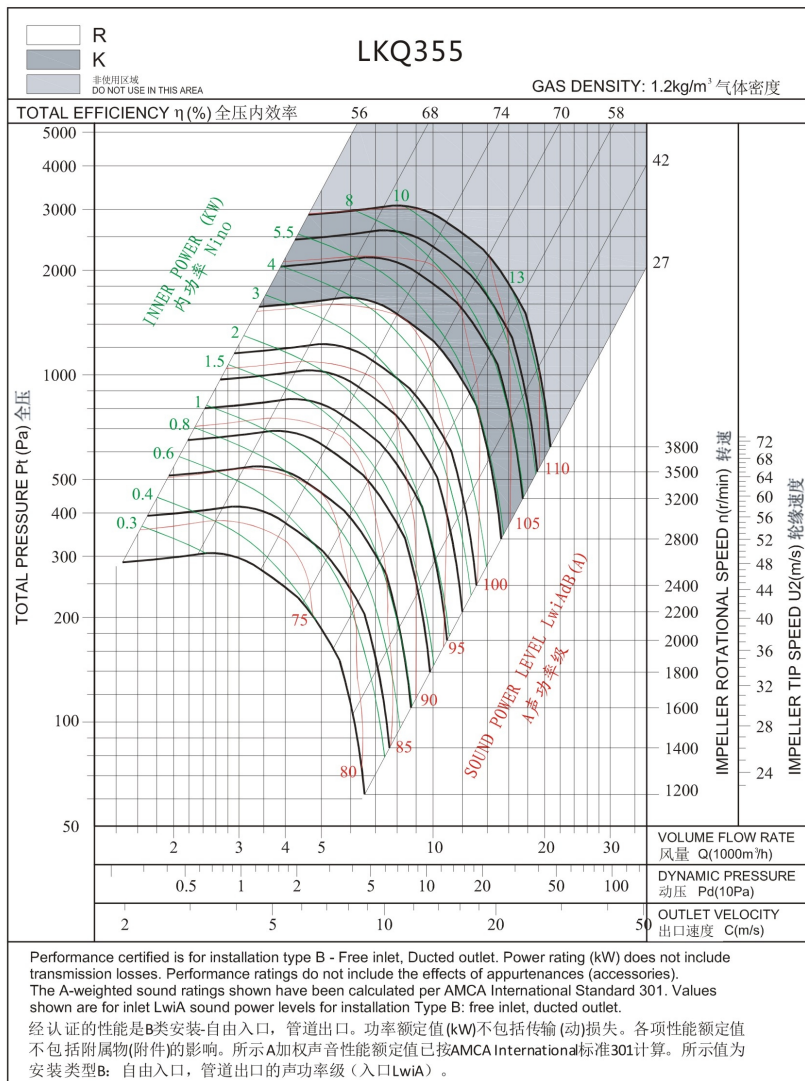

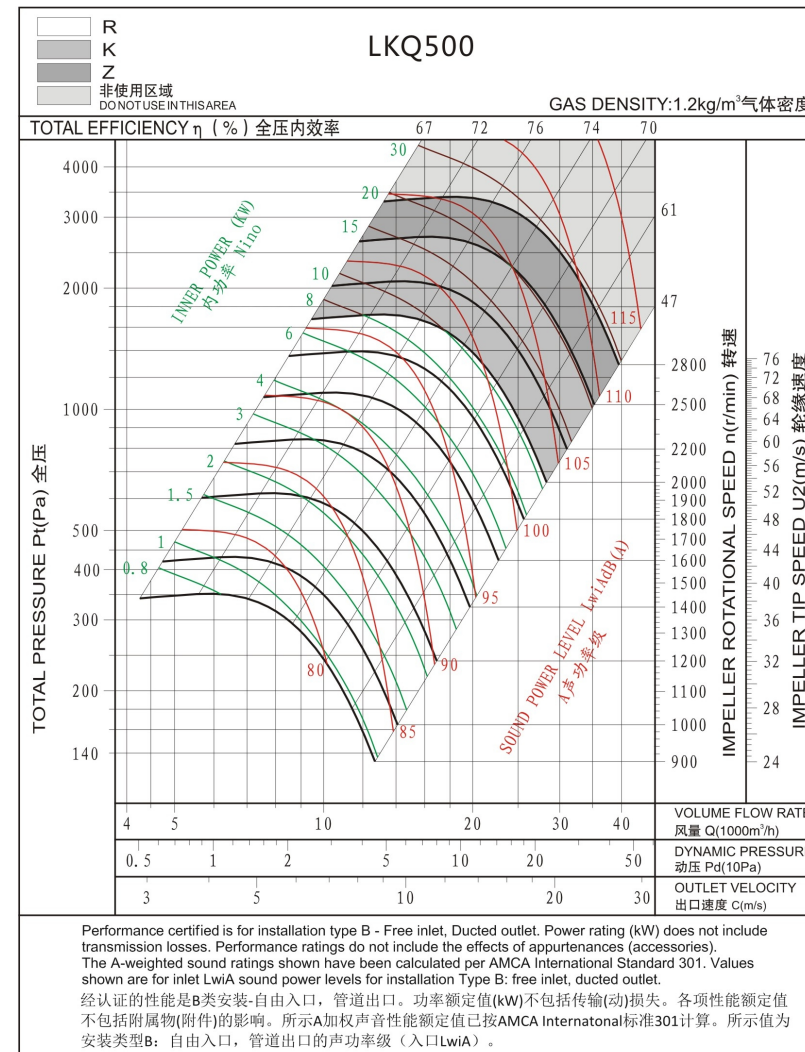
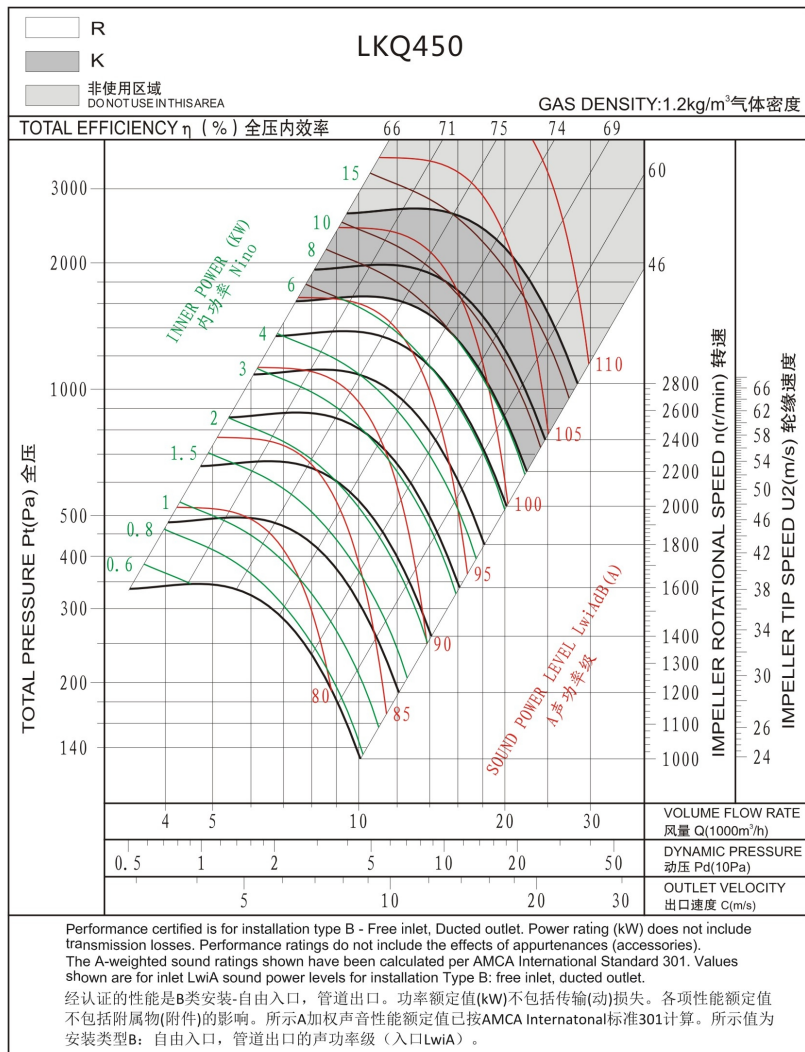

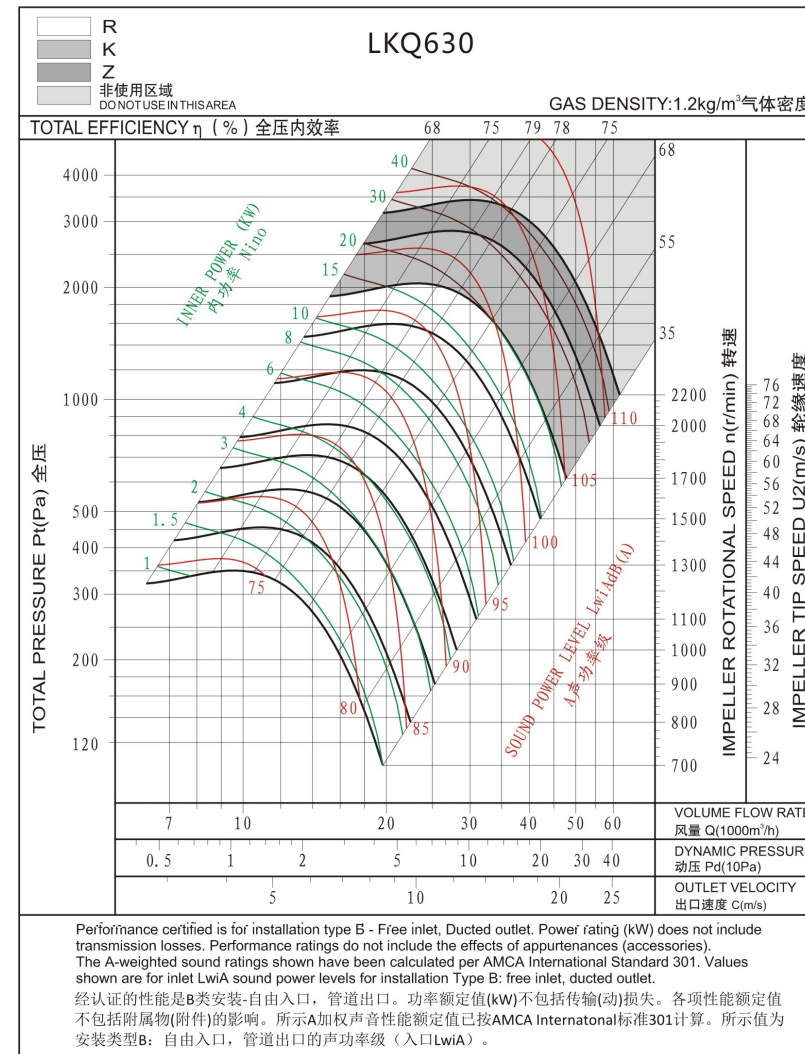
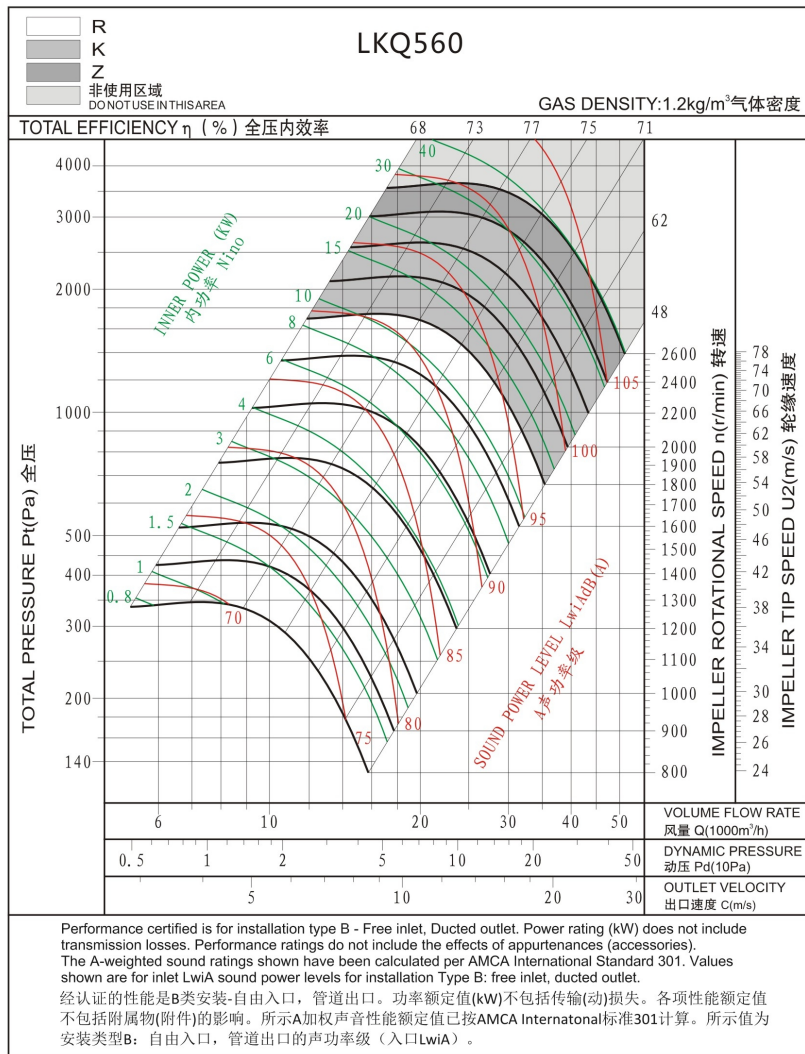

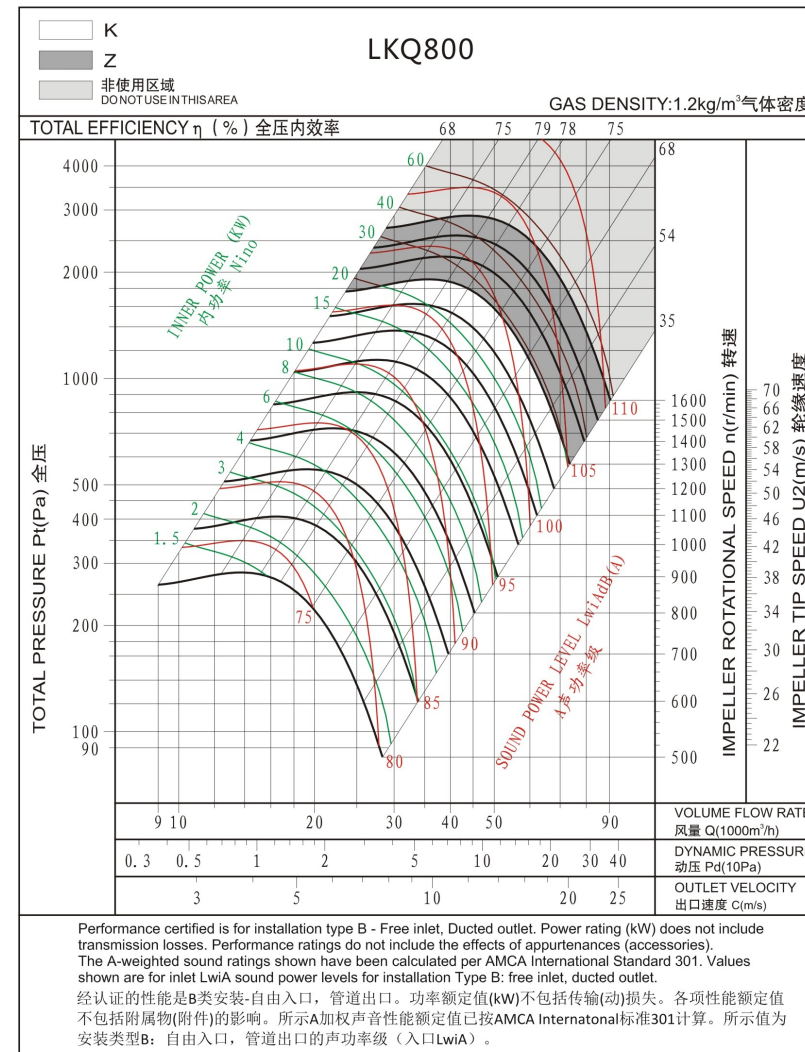
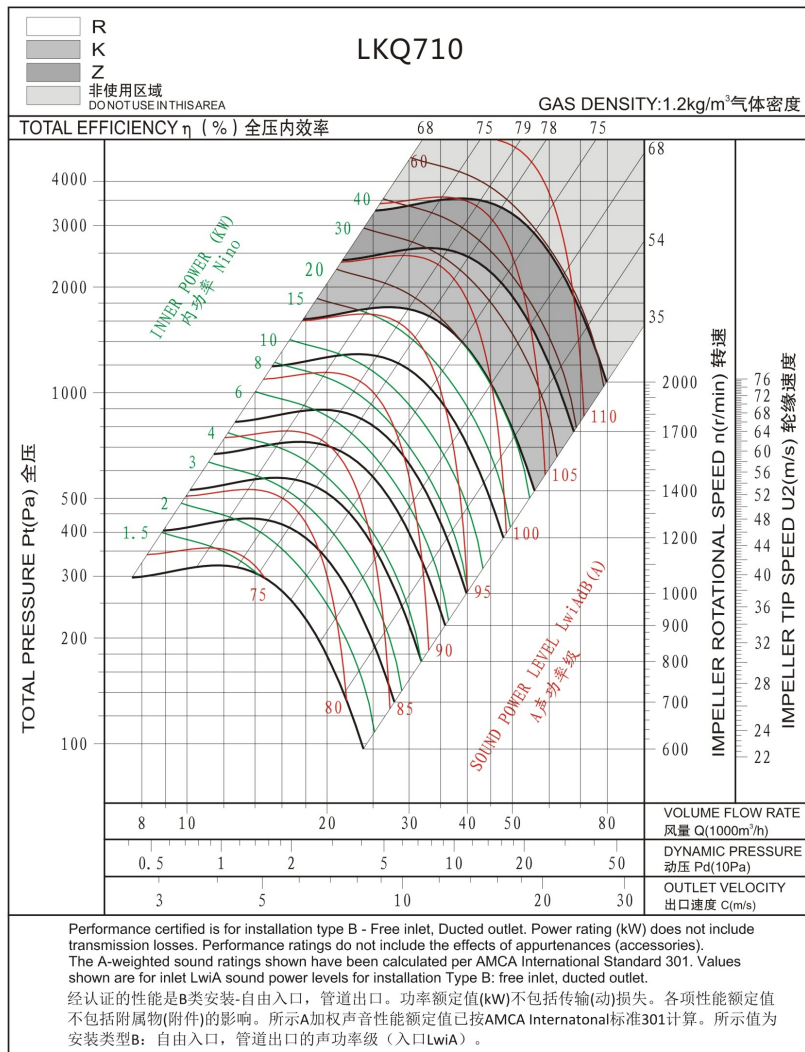

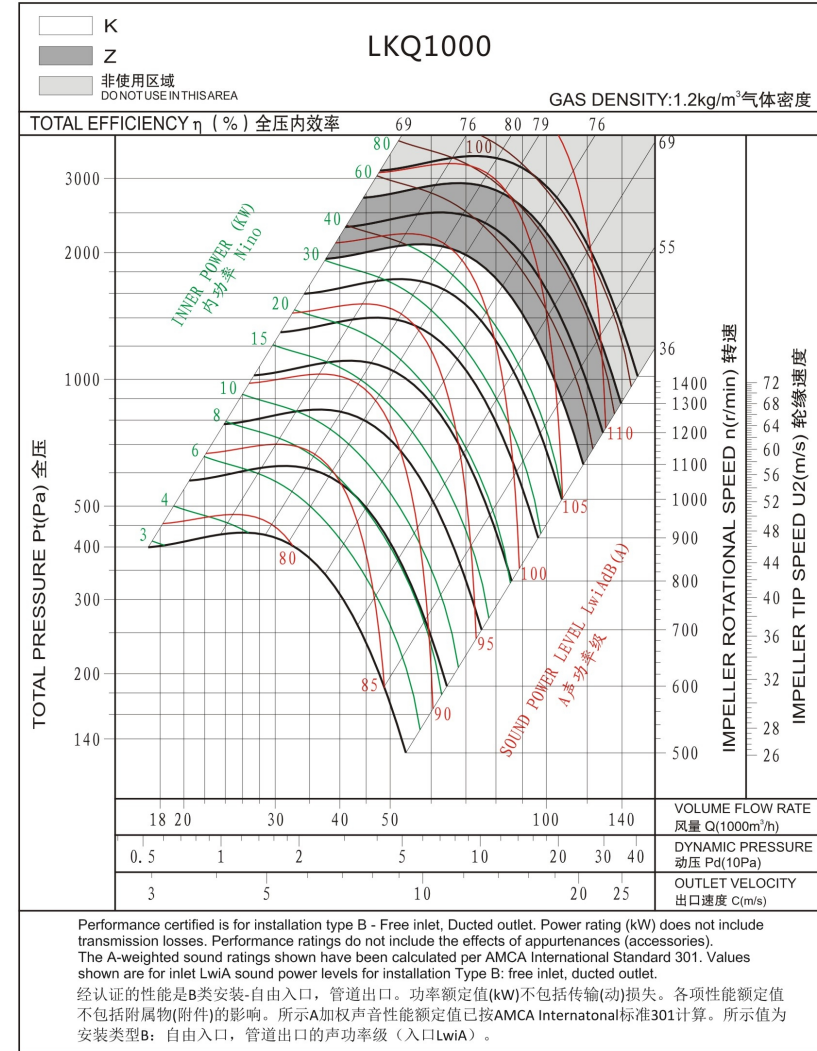
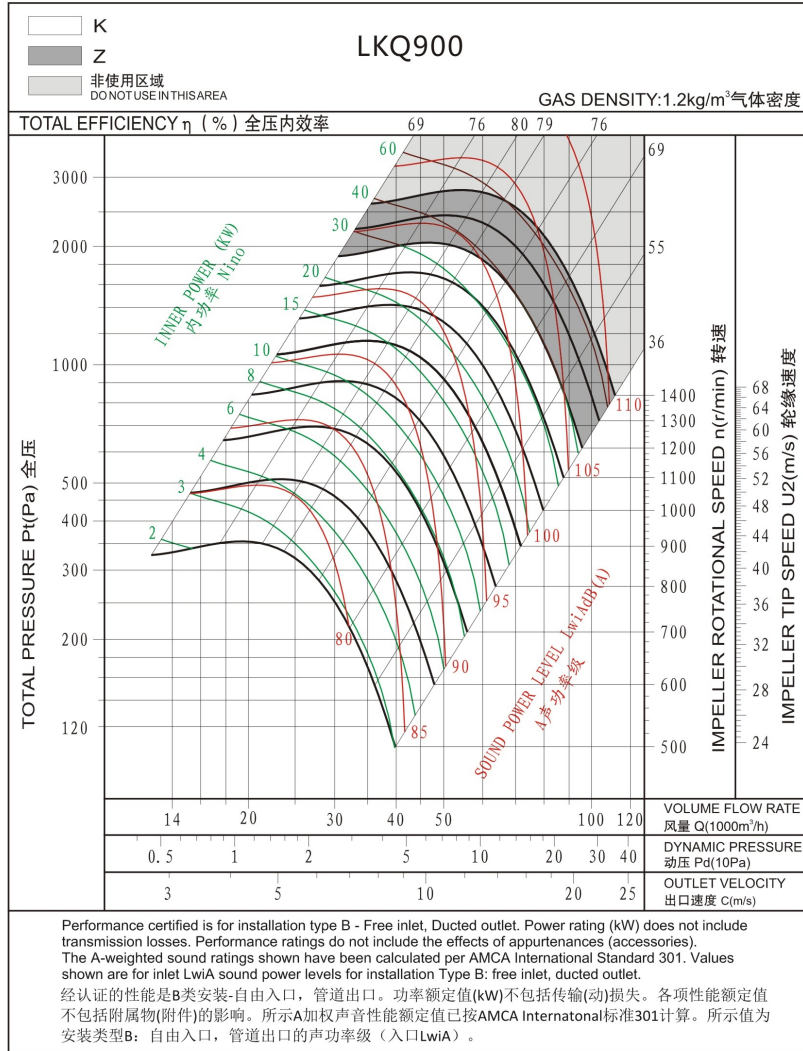



LKQ-R

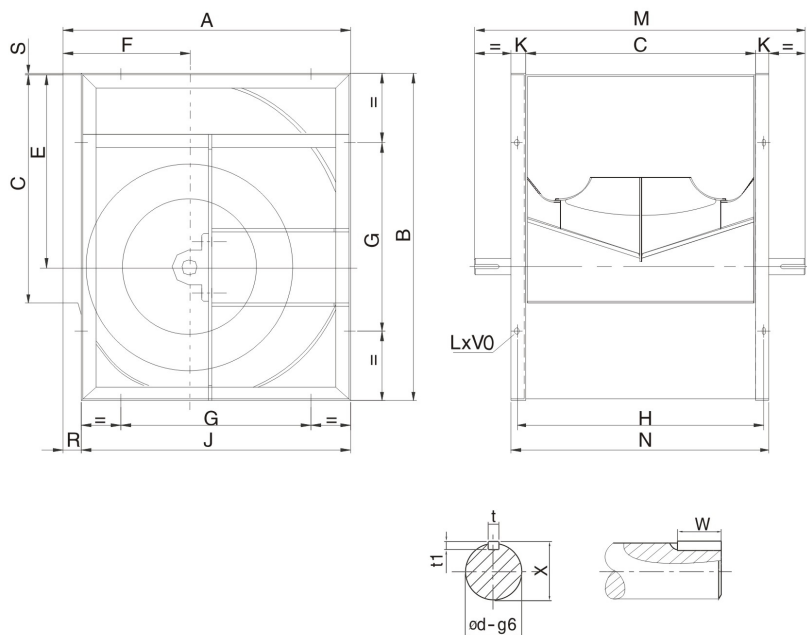

Model	A	B	C	E	F	G	H	J	K	M	N	R	S	t	t1	W	X	φd	LxV
280	466	518	361	302	215	280	391	432	30	575	421	34	5	8	7	50	28	25	13x18
315	518	578	404	340	236	280	434	480	30	640	464	38	3	8	7	60	28	25	13x18
355	578	655	453	383	261	355	493	548	40	700	533	30	6	8	7	60	33	30	13x18
400	651	736	507	431.5	290	355	547	613	40	760	587	38	4.5	8	7	60	33	30	13x18
450	726	827	569	486	322	530	609	681	40	845	649	45	5	10	8	70	38	35	13x18
500	800	918	638	538	352	530	678	750	40	915	718	50	5	10	8	70	38	35	13x18
560	893	1030	715	602	390	530	765	845	50	1000	815	48	8	12	8	70	43	40	13x18
630	999	1157	801	678.5	434	530	851	946	50	1090	901	53	7	14	9	70	48.5	45	13x18
710	1121	1303	898	765	485	630	948	1058	50	1255	998	63	7	14	9	90	53.5	50	17x22



LKQ-K (Z)

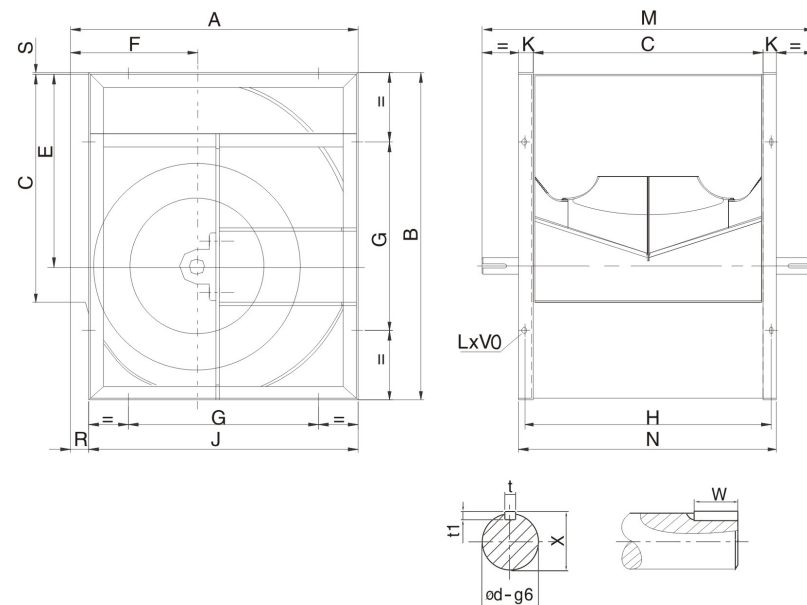

Model	A	B	C	E	F	G	H	J	K	M	N	R	S	t	t1	W	X	φd	LxV
280	466	518	361	302	215	280	391	432	30	600	421	34	5	8	7	60	33	30	13x18
315	518	578	404	340	236	280	434	480	30	665	464	38	3	8	7	70	33	30	13x18
355	578	655	453	383	261	355	493	548	40	725	533	30	6	10	8	70	38	35	13x18
400	651	736	507	431.5	290	355	547	613	40	790	587	38	4.5	10	8	70	38	35	13x18
450	726	827	569	486	322	530	609	681	40	890	649	45	4.5	12	8	90	43	40	13x18
500	800	918	638	538	352	530	678	750	40	960	718	50	5	12	8	90	43	40	13x18
560	893	1030	715	603	390	530	765	845	50	1070	815	48	8	14	9	90	53.5	50	13x18
630	999	1157	801	678.5	434	530	851	946	50	1155	901	53	7	14	9	90	53.5	50	13x18
710	1121	1303	898	765	485	630	948	1058	50	1290	998	63	7	18	11	90	64	60	17x22
800	1250	1468	1007	862	535	710	1057	1181	50	1450	1107	69	7	18	11	90	64	60	17x22
900	1408	1648	1130	971	604	800	1180	1319	60	1570	1250	89	7	18	11	100	69	65	17x22
1000	1541	1810	1267	1066	657	900	1317	1462	60	1700	1387	79	9	18	11	100	69	65	17x22



LKQ-R (K) 2

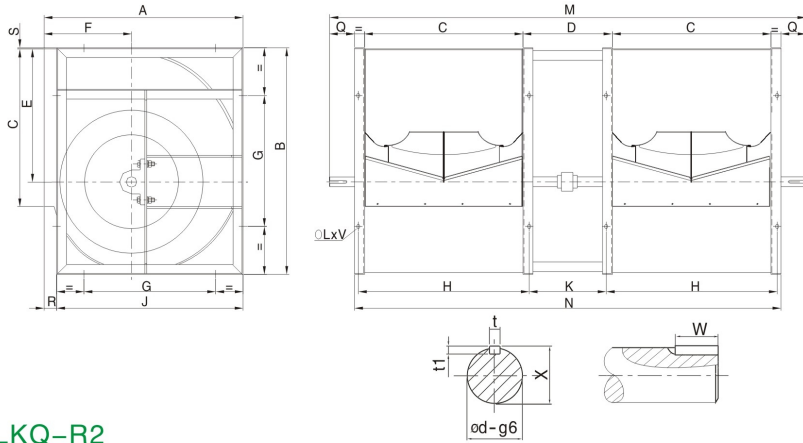

LKQ-R2

Model	A	B	C	D	E	F	G	H	J	K	M	N	Q	R	S	t	t1	W	X	φd	LxV
280	466	518	361	280	302	214	280	391	432	250	1216	1060	77	34	5	8	7	50	28	25	13x18
315	518	578	404	315	340	236	280	434	480	285	1359	1183	88	38	3	8	7	60	28	25	13x18
355	578	654	453	355	383	260	355	493	548	315	1508	1339	83.5	30	6	8	7	60	33	30	13x18
400	650	736	507	400	432	290	355	547	612	360	1667	1492	86.5	38	4.5	8	7	60	33	30	13x18
450	726	827	569	450	486	322	530	609	681	410	1864	1666	98	45	5	10	8	70	38	35	13x18
500	800	918	638	500	538	352	530	678	750	460	2053	1856	98.5	50	5	10	8	70	38	35	13x18
560	893	1030	715	560	602	390	530	765	845	510	2275	2090	92.5	48	8	12	8	70	43	40	13x18
630	999	1157	801	630	678.5	434	530	851	946	580	2521	2332	94.5	53	7	14	9	70	48.5	45	13x18
710	1121	1303	898	710	765	485	630	948	1058	660	2863	2606	128.5	63	7	14	9	90	53.5	50	17x22

LKQ-K2

Model	A	B	C	D	E	F	G	H	J	K	M	N	Q	R	S	t	t1	W	X	φd	LxV
355	578	654	453	355	383	260	355	493	548	315	1533	1339	96	30	6	10	8	70	38	35	13x18
400	650	736	507	400	432	290	355	547	612	360	1697	1492	99	38	4.5	10	8	70	38	35	13x18
450	726	827	569	450	486	322	530	609	681	410	1909	1666	120.5	45	5	12	8	90	43	40	13x18
500	800	918	638	500	538	352	530	678	750	460	2098	1856	121	50	5	12	8	90	43	40	13x18
560	893	1030	715	560	602	390	530	765	845	510	2345	2090	127.5	48	8	14	9	90	53.5	50	13x18
630	999	1157	801	630	678.5	434	530	851	946	580	2586	2332	127	53	7	14	9	90	53.5	50	13x18
710	1121	1303	898	710	765	485	630	948	1058	660	2898	2606	146	63	7	18	11	90	64	60	17x22
800	1250	1468	1007	800	862	535	710	1057	1181	750	3257	2914	171.5	69	7	18	11	90	64	60	17x22
900	1408	1648	1130	900	971	604	800	1180	1319	850	3600	3280	160	89	7	18	11	100	69	65	17x22
1000	1541	1810	1267	1000	1066	657	900	1317	1462	950	3967	3654	156.5	79	7	18	11	100	69	65	17x22



LKQ-L

		0°			90°			180°		
左旋LG										
右旋RD										
型号 Model	电机 机座型号 Motor Frame Size	A	B	C	A	B	C	A	B	C
200	56	560	420	394	580	420	348	560	420	396
	63	600	420	394	620	420	348	600	420	396
	71	640	420	394	660	420	348	640	420	396
	80	680	420	394	700	420	348	680	420	396
225	63	630	460	439	660	460	384	630	460	440
	71	670	460	439	700	460	384	670	460	440
	80	710	460	439	740	460	384	710	460	440
	90	450	460	439	780	460	384	750	460	440
250	63	660	490	484	680	490	422	660	490	482
	71	700	490	484	720	490	422	700	490	482
	80	740	490	484	760	490	422	740	490	482
	90	780	490	484	800	490	422	780	490	482

LKQ-R

		0°			90°			180°		
左旋LG										
右旋RD										
型号 Model	电机 机座型号 Motor Frame Size	A	B	C	A	B	C	A	B	C
200	56	560	420	394	580	420	348	560	420	396
	63	600	420	394	620	420	348	600	420	396
	71	640	420	394	660	420	348	640	420	396
	80	680	420	394	700	420	348	680	420	396
225	63	630	460	439	660	460	384	630	460	440
	71	670	460	439	700	460	384	670	460	440
	80	710	460	439	740	460	384	710	460	440
	90	450	460	439	780	460	384	750	460	440
250	63	660	490	484	680	490	422	660	490	482
	71	700	490	484	720	490	422	700	490	482
	80	740	490	484	760	490	422	740	490	482
	90	780	490	484	800	490	422	780	490	482

- 本手册所述之产品，因更新和改良，可能不经事先通知，特此声明敬请谅解。
- 由于手册的原因产品跟实际颜色有差异，敬请谅解。
- 浙江莱恩克风机有限公司保留对本手册的最终解释权。

NOTE: This catalogue is for reference only.
We reserve the rights to make any improvements
and changes for the products in future.



LKQ系列离心式空调风机技术手册 The LKQ Series Centrifugal Fan

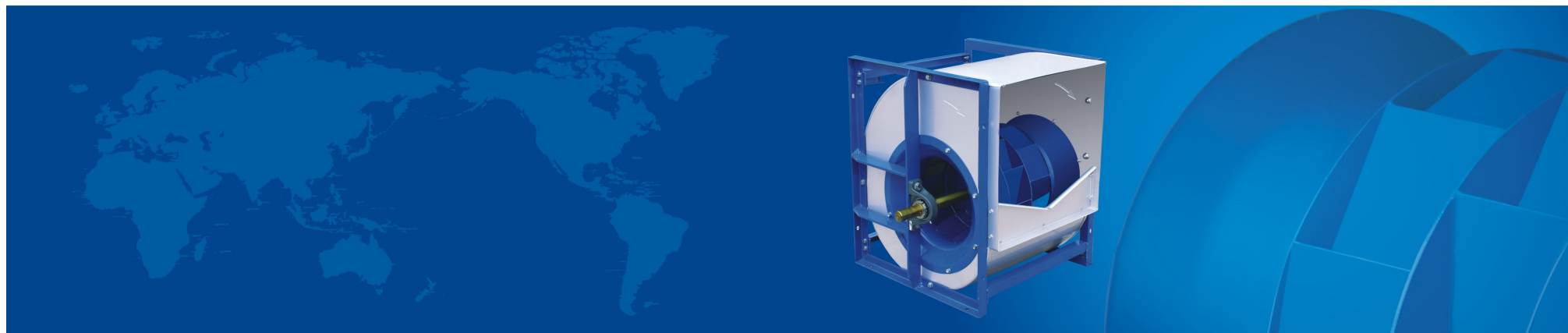

浙江莱恩克风机有限公司
ZHEJIANG LION KING VENTILATOR CO., LTD.



Megan Chan
General Sales Manager
Zhejiang Lion King Ventilator Co., Ltd.

☎ 008618167069821
✉ lionking@lkfan.com
🌐 <https://www.lkventilator.com/>
📍 Add.: No. 698, Yangsi Road, Zhong'an, Jiaojiang District, Taizhou City., Zhejiang Province, China

浙江莱恩克风机有限公司
ZHEJIANG LION KING VENTILATOR CO., LTD.



企业理念

Qualification Certificate

诚信立足，创新发展，共赢致远……

Based on Honesty, Innovation to Promote Development, Mutual Benefits Lead to Great Future

诚信是莱恩克公司的立身之本。莱恩克一贯奉行全方位的诚信理念，倡导企业管理层、员工诚信经营、诚信服务，倡导向社会、客户、合作伙伴和谐发展，为铸造百年企业打下扎实根基。

创新是莱恩克公司的活力之源。公司大力倡导创新精神，积极营造尊重劳动、尊重知识、尊重人才、尊重创造的良好氛围，在实践中不断推进体制、机制、科技、产品等创新活动，为社会提供更优质的产品和服务。

共赢是莱恩克公司的致远之道。公司通过诚信的态度，务实的作风，创新的思维，努力达成企业、员工、客户、合作伙伴、社会多方共赢，使得企业长远稳定发展。

Honesty is the foundation of LION KING. We consistently pursue good faith as our principle. We advocate our managers and employees operating honestly, and we advocate to develop with society, customers and partners in harmony to make our company to exist more than one hundred years.

Innovation is the source of vitality of LION KING. We advocate innovation, and actively create good atmosphere for innovation, such as respecting talents, respecting knowledge, respecting hardworking, respecting creation. And in practice, we continue to promote innovation of our system, mechanism, technologies and products.

Mutual benefits are the way to lead us to a great future. With honest attitude, pragmatic work style and innovative thinking, we'll try our best to achieve multi-win situation for our company, employees, customers, partners and the society, which will help us for a long-time sustainable development.



Contents 目录

LKQ系列离心式空调风机产品说明	01
LKQ Series centrifugal Fan Instructions	
LKQ系列离心式空调风机技术参数	09
LKQ Series centrifugal Fan Technical Parameters	



命名方式

LKQ系列风机命名方式由风机系列代号、叶轮名义直径、结构型式组成：

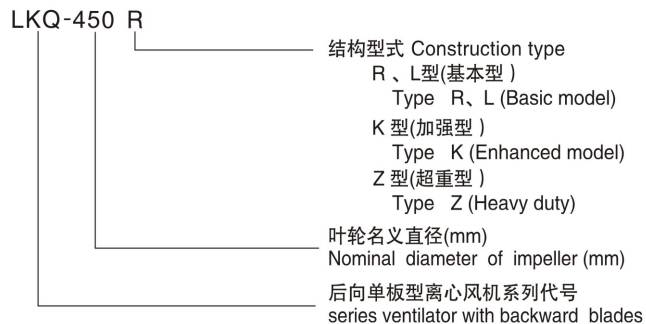

Nomenclature

The model designations signify the nominal impeller outside diameters:

产品形式

1. 旋向

LKQ系列风机可分为左旋(LG)和右旋(RD)两种旋转方式，从风机皮带轮一端正视，叶轮顺时针旋转的称为右旋风机，逆时针旋转的称为左旋风机。皮带轮可左右调向，因此不受左右方向的限制。

LKQ Series ventilator can be divided into two direction of rotations, left-hand rotation(LG) and right-hand rotation (RD); Viewing from end of motor outlet line if the impeller rotates clockwise, it is called right hand ventilator, if the impeller rotates anti-clockwise, it is called left hand ventilator. The pulley can adjust its direction, left or right, therefore there is no limitation in directionality.

2. 出风口方向

LKQ系列风机可按图1所示制成0°、90°、180°、270°四种出风方向。

2. Direction of Air Outlet

According to Fig 1, LKQ Series ventilator can be made in four air-outlet directions: 0°, 90°, 180°, and 270°.



图1(Fig1)



3. 结构形式

LKQ系列风机分为R型、K型和Z型三种形式，R型为基本型，K型为用于大功率的加强型，Z型用于重载的超重型。

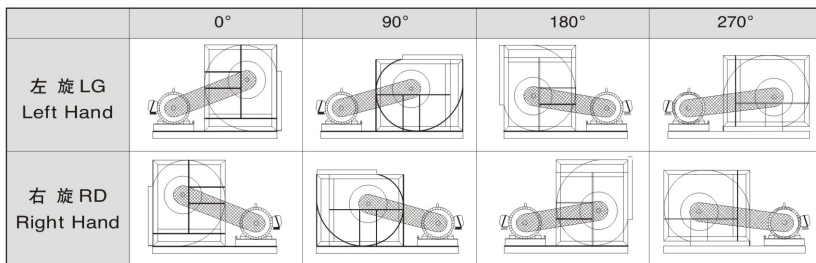
3. Type of structure

There are three types of LKQ ventilators, type R, type K and type Z. The type R represents the basic model, while the type K is designed for use at the higher power levels, and the type Z at the heavy duty levels.

产品结构

LKQ系列风机主要由机壳、叶轮、框架、轴承、轴、出风口法兰(常规配置不带法兰)构成。

Constructor of Product

The major components of the LKQ Series ventilators include the scroll, impeller, frame, bearings, shaft, and outlet flange. (Outlet flange should be indicated when placing order)

1) 机壳

机壳采用热镀锌钢板制造，侧板具有符合空气动力学的外形，进风口整体拉伸成型，蜗板采用咬口或点焊的方式与侧板连接成一体。

1) Scroll

The scroll is made of hot galvanized steel sheet, and it is designed to provide an aerodynamically efficient flow path. The inlet is formed in one piece. The scroll is fixed to the side plates by "spot welding" or "seam locking".

2) 叶轮

叶轮采用优质冷轧钢板制成，按三元流理论设计的单板型叶片焊接在经数控机床加工的中盘和端圈上，整体喷塑。叶轮按高于国家标准的内控动平衡精度等级全检合格。

2) Impeller

The LKQ impeller is made of high grade cold-rolled steel sheet. It is to provide a highly efficient and low noise and specially-designed blades, are welded on the center disc, and painted with polyester coatings. The impellers are dynamic balanced testing balanced before assembly in accordance with national standards.

3) 框架

框架由角钢和扁钢焊接制成，表面喷塑，以保证足够的刚度和强度。

3) Frame

The frames of LKQ made of angle flat steel to assure sufficient frame rigidity and intensity they are painted with polyester coatings.

4) 轴承

轴承均采用优质滚珠或滚柱轴承，并根据噪声最低来选择，该轴承设有加润滑油的孔，已预先加润滑油并自动对中。L、R、K型风机采用向心球轴承，Z型风机采用重载荷的双列滚柱轴承的轴承箱结构。

4) Bearings

Out-spherical ball bearings are used LKQ Series ventilators. They are high quality with low noise ventilator. The bearing are supplied with lubrication fittings, they are pre-lubricated, sealed and self centering. For type L、R、K ventilators, self-aligning ball bearings are used, for type Z ventilators, heavy duty bearings housings are used.

5) 轴

风机轴采用特制钢经粗加工、调质处理及磨削精加工制成，严格控制轴径尺寸公差及形位公差，每根轴均经过涂覆防锈处理。

5) Shaft

The shafts are made of 40 Cr or C45 carbon steel bars. The shafts are rough machined and then stress relieved before final machining. The shaft diameters are machined to very accurate tolerance levels and they are fully checked to assure precision fits. They are coated after assembly in order to provide corrosion resistance.

6) 出风口法兰

法兰采用热镀锌钢板制造，法兰与壳体的连接采用TOX免焊工艺或螺栓连接，外观精美，并具有足够的刚度与强度。法兰口形式参照下页图2所示。

6) Outlet Flange

The outlet flange is made of galvanized steel sheet. The connections of the flange to the scroll is made using a TOX non-welding process. This maintains a good flange appearance while also providing sufficient strength and rigidity. The outlet flange dimensions are provided in Figure 2.

此段内容再让外贸校对到底要怎么改？